

Varenummer: 2032100M840A1S  
 Beskrivelse: E+G Justerfod  
 GN 32-100-M8-40-A1-S  
 Note: S Uden møtrik, udvendig sekskant i bunden

## Mål

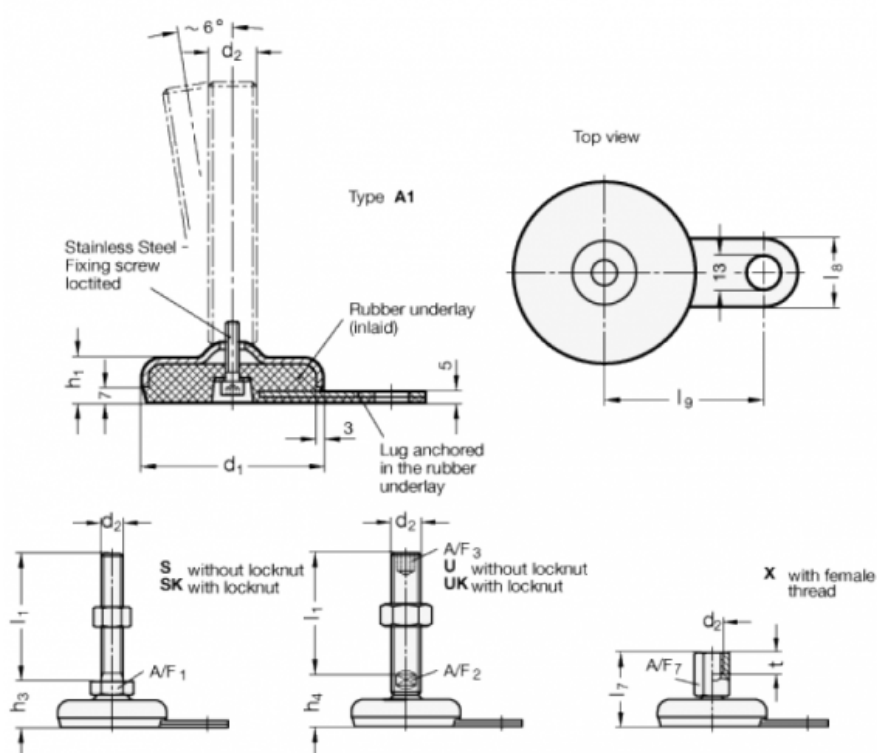

A/F1	=	17
d1	=	100
d2	=	M8
h1	=	21
h3	=	29
l1	=	40
l8	=	30
l9	=	80